

ROHRHEIZPATRONEN

TUBULAR CARTRIDGE HEATERS



FIRMENGRUPPE / GROUP OF COMPANIES



IHNE & TESCH
ELEKTRO-WÄRMETECHNIK

KELLER IHNE + TESCH
ELEKTRO-WÄRMETECHNIK

CELTIC

KIT ELECTROHEAT

ROHRHEIZPATRONEN

TUBULAR CARTRIDGE HEATERS

Typen / Types

	RPM	RDO	RP	RPO	RPS spannbar clampable	RP Druckguss diecast	RPI	RPI spannbar clampable
Einsatztemperatur¹⁺² operating temperature ¹⁺²	600 °C				600 °C	750 °C	450 °C	
max. Leistungsdichte¹ max load ¹	15 W/cm ²				15 W/cm ²	8 W/cm ²	6 W/cm ²	
Betriebsspannung operating voltage	230 Volt							
Wandstärke wall thickness	5 mm		7,5 - 10 mm		5 - 10 mm	5 - 10 mm	3 mm	
Spannverschluss clamp lock	-	-	-	-	1 mm Spannband 1 mm clamp band	-	-	L < 79 mm ⁴ : 1 x L > 79 mm ⁴ : 2 x
Mantel- oder Dornheizung jacket or mandrel heater	Mantel jacket	Dorn mandrel	Mantel jacket	Dorn mandrel	Mantel jacket			
Mantelmaterial jacket material	Edelstahl 1.4541 oder 1.4301 stainless steel 1.4541 or 1.4301							
Druckgussausführung möglich suitable for die-cast	x	-	x	-	x	x	-	-
Innendurchmesser³ internal diameter ³	H7 - H12	± 1 mm	H7 - H12	± 1 mm	H12	H7 - H12	H8 - H12 ³	
Außendurchmesser³ outer diameter ³	± 0,25 mm/ ± 0,35 mm	h8 / h12	± 0,25 mm/ ± 0,35 mm	h8 / h12	± 0,35 mm	± 0,35 mm	± 0,2 - ± 0,5 mm	
Längentoleranz length tolerance L 30 - 100 mm L 101 - 150 mm L 151 - 300 mm L 301 - 400 mm	± 3 mm ± 4 mm ± 5 mm -	± 3 mm ± 4 mm ± 5 mm ± 6 mm	± 3 mm ± 4 mm ± 5 mm -	± 3 mm ± 4 mm ± 5 mm ± 6 mm	± 3 mm ± 4 mm ± 5 mm -	± 3 mm ± 4 mm ± 5 mm -	± 3 mm ± 4 mm ± 5 mm -	± 3 mm
Anschlussausführungen connection types	Abb.1 - 11 fig. 1 - 11	Abb.1 + 2 fig. 1 + 2	Abb.1+2/5 - 11 fig. 1+2/5 - 11	Abb.1 + 2 fig. 1 + 2	Abb.8 - 11 fig. 8 - 11		Abb.3 - 7 + 12 - 13 fig. 3 - 7 + 12 - 13	
Temperatursensor temperature sensor	Typ: L, J + K type: L, J + K					Typ: K type: K	Typ: L, J + K type: L, J + K	
Leistungstoleranz performance tolerance	± 10 %							
Hochspannungsfestigkeit high voltage stability	1200 Volt AC						1000 Volt AC	
Isolationswiderstand insulation resistance	kalt ≥ 5 MOhm bei 500 Volt DC cold ≥ 5 MOhm at 500 Volt DC							
Ableitstrom derivated power	kalt ≤ 0,5 mA bei 253 Volt DC cold ≤ 0.5 mA at 253 Volt DC							

¹⁾ max. am Patronenmantel / max. at cartridge jacket

²⁾ Einsatztemperatur und max. Leistungsdichte sind immer in Abhängigkeit voneinander / operating temperature and max. load are always dependent to each other

³⁾ längenabhängig / depending on length

⁴⁾ 1 mm starker Spannverschluss siehe Abb. 12 + 13, ab Ø 19 mm möglich / 1 mm strong clamp lock see fig. 12 + 13, possible from Ø 19 mm

zulässige Oberflächentemperaturen in °C
allowable surface temperature in °C

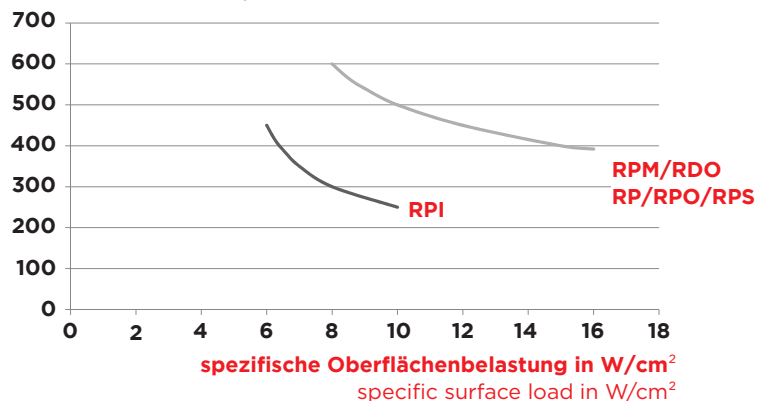

Technische Änderungen vorbehalten

subject to technical change



IHNE & TESCH
ELEKTRO-WÄRMETECHNIK

KELLER IHNE + TESCH
ELEKTRO-WÄRMETECHNIK

CELTIC

KIT ELECTROHEAT

www.elektrowaermetechnik.de

Anschlussausführungen / Connection options



Abb. 1: stirnseitig
fig. 1: frontal



Abb. 2: stirnseitig + Zugentlastung
fig. 2: frontal + strain relief

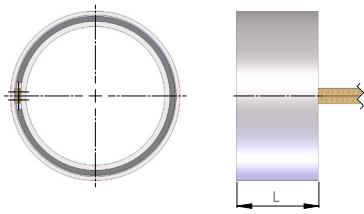

Abb. 3: Flachkappe axial Ausführung 3
fig. 3: axial flat cap option 3

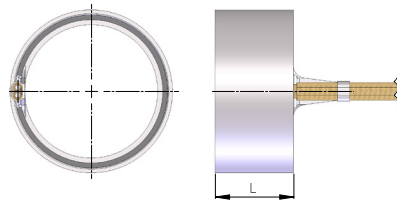

Abb. 4: Flachkappe tangential Ausführung 4
fig. 4: tangential flat cap option 4

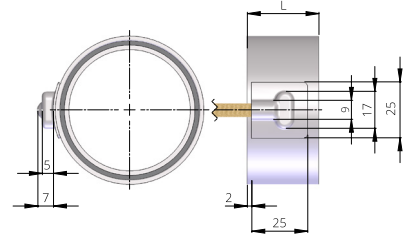

Abb. 5: RPM Kappe tangential 45° Ausführung 6
fig. 5: 45° tangential RPM cap option 6

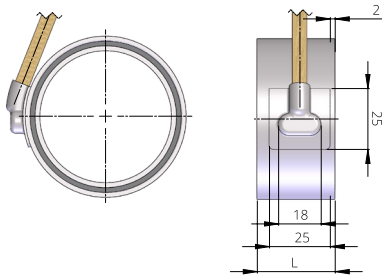

Abb. 6: RPM Kappe radial Ausführung 7
fig. 6: radial RPM cap option 7

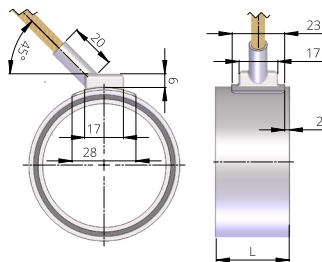

Abb. 7: RPM Kappe axial 45° Ausführung 8
fig. 7: 45° axial RPM cap option 8

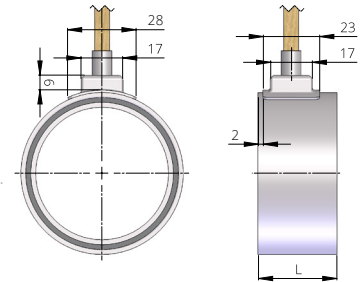

Abb. 8: Düsenkappe axial 45°
fig. 8: 45° axial nozzle cap

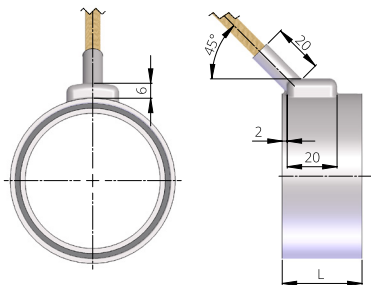

Abb. 9: Düsenkappe axial 5°
fig. 9: 5° axial nozzle cap

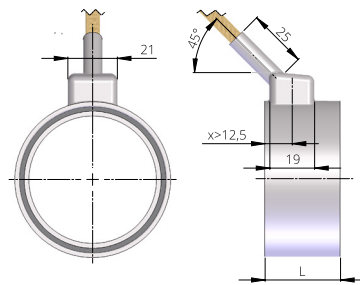

Abb. 10: Düsenkappe radial
fig. 10: radial nozzle cap

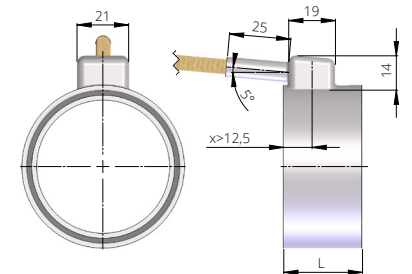

Abb. 11: Düsenkappe tangential
fig. 11: tangential nozzle cap

Technische Änderungen vorbehalten

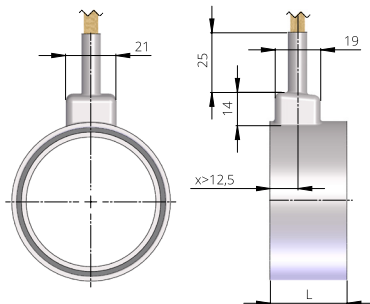
subject to technical change

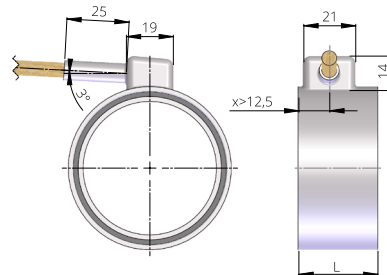

IHNE & TESCH
ELEKTRO-WÄRMETECHNIK



KELLER IHNE + TESCH
ELEKTRO-WÄRMETECHNIK

CELTIC

KIT ELECTROHEAT

www.elektroaermetechnik.de

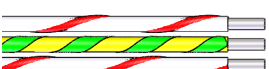
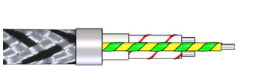
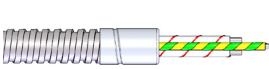
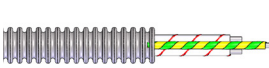
Kabelauführungen / Cable exit options

	glasseidenisierte Nickellitze bis 400 °C (GLS 400) oder 700 °C (GLS 700) fibreglass insulated nickle leads up to 400 °C (GLS 400) or 700 °C (GLS 700)
	glasseidenisierte Nickellitze bis 400 °C (GLS 400) oder 700 °C (GLS 700) mit Schutzleiter (SL) / fibreglass insulated nickle leads up to 400 °C (GLS 400) or 700 °C (GLS 700) with earth protection (SL)
	Drahtgeflechschlauch Stahl verzinkt oder Edelstahl + Schutzleiter bis 400 °C oder 700 °C 3-core cable and metal braided hose steel or stainless steel + earth protection up to 400 °C / 700 °C
	Spiralschlauch Stahl verzinkt oder Edelstahl + Schutzleiter 400 °C / 700 °C 3-core cable and spiral hose steel or stainless steel + earth protection up to 400 °C / 700 °C
	Wellschlauch Stahl verzinkt oder Edelstahl + Schutzleiter 400 °C / 700 °C 3-core cable and wave hose steel or stainless steel + earth protection up to 400 °C / 700 °C
	glasseidenisierte Nickellitze zus. mit unbeschichtetem Glasseidenschlauch (400 °C) überzogen fibreglass insulated nickle leads additional covered with un-coated fibreglas hose (400 °C)
	Teflon Litze (PTFE), 2- oder 3-adrig, temperaturbeständig bis max. 260 °C teflon insulated leads (PTFE), 2- or 3-core, temperature-stable up to max. 260 °C

Ausführungsbeispiele / Construction design examples

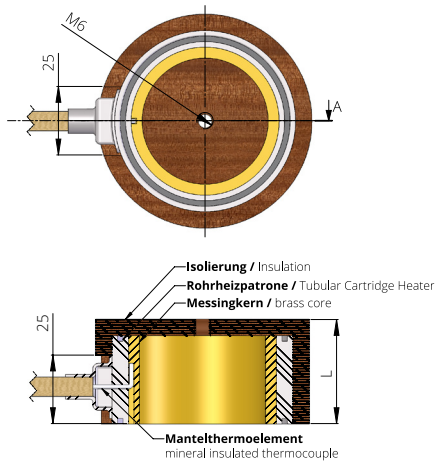

mit Messingring + ISO
with brass ring and isolation

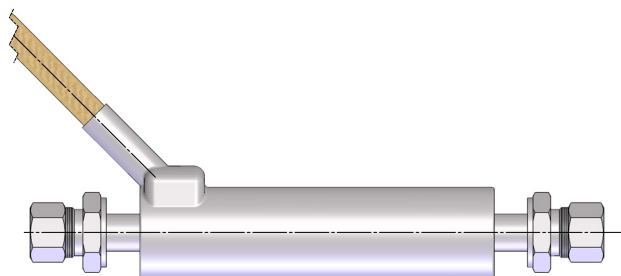

als Durchlauferhitzer
as flow type heater

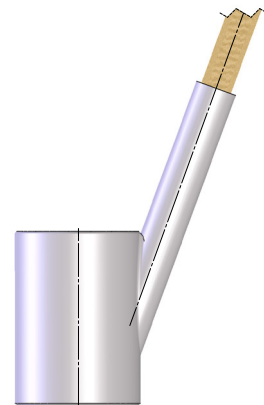

mit Anschlussrohr
with connection tube

RPI

Abb. 12: RPI axial mit Abdeckblech
fig. 12: axial RPI with cover plate



Abb. 13: RPI radial mit Abdeckblech
fig. 13: radial RPI with cover plate



Optionen / Options

- › **verschiedene Abmessungen (Ø/Länge)**
various dimensions (Ø/length)
- › **Spannungs- und Leistungsvarianten**
various voltage and wattage
- › **diverse Anschlusslängen und -typen**
various lead lengths and types
- › **andere Leistungstoleranzen**
other performance tolerances
- › **konische Kontaktfläche**
conical contact surface
- › **Ein- und Ausbauhilfe**
assembly and disassembly kit
- › **mit Anschlussstiften und Stirnseite plan**
with connection pins and plane front side
- › **mit Leistungsverteilung**
with capacity distribution
- › **Anschlusskabel mit diversen Steckern**
cable leads with various plugs
- › **andere Kabellängen**
other cable lengths
- › **mit integriertem Temperatursensor**
with integral temperature sensor

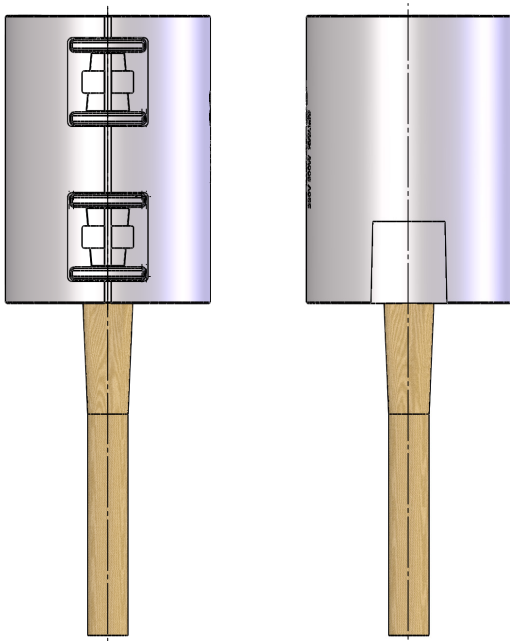
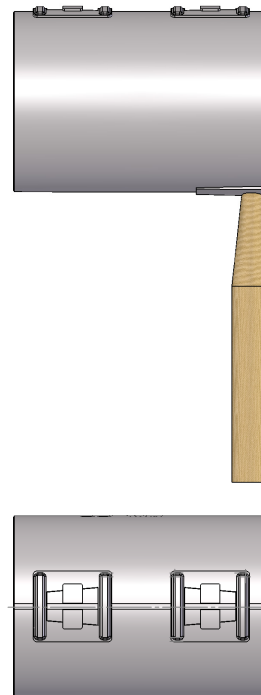
Technische Änderungen vorbehalten

subject to technical change



IHNE & TESCH
ELEKTRO-WÄRMETECHNIK

KELLER IHNE + TESCH
ELEKTRO-WÄRMETECHNIK

CELTIC

KIT ELECTROHEAT

www.elektrowaermetechnik.de

Standorte

Locations



RHP 06/2023

GERMANY

Ihne & Tesch GmbH
Am Drostenstein 18
D-58507 Lüdenscheid
Postfach 1863
D-58468 Lüdenscheid

Telefon: +49 2351 666 0
Telefax: +49 2351 666 24
info@itnmail.de

Ihne & Tesch GmbH
Aalener Straße 42
D-90441 Nürnberg

Telefon: +49 911 96678 0
info@itnmail.de

www.elektroaermetechnik.de

Ihne & Tesch GmbH & Co. KG
Kunigundenstraße 13
D-68623 Lampertheim
Postfach 5164
D-68612 Lampertheim

Telefon: +49 6241 98808 0
Telefax: +49 6241 80056
info@kitmail.de

www.elektroaermetechnik.de



AUSTRIA

Keller, Ihne & Tesch GmbH
Bahnhofstraße 90
A-3350 Haag

Telefon: +43 7434 43880
Telefax: +43 7434 43883
info@kitmail.at

www.elektroaermetechnik.at

FRANCE

Celtic S.A.R.L.
2/4 Rue René Cassin
ZAC La Villette-aux-Aulnes
F-77290 Mitry-Mory

Téléphone: +33 160 21 21 80
Téléfax: +33 160 21 21 81
info@celtic.fr

www.celtic.fr

GREAT BRITAIN

KIT Electroheat Ltd.
Mexborough Business Centre
College Rd
GB-S64 9JP Mexborough

Phone: +44 1443 442 176
Fax: +44 1443 441 861
mail@kitelectroheat.co.uk

www.kitelectroheat.co.uk